

# **Face recognize & temperature measurement panel**

user manual

## Foreword

The purpose of this section is to ensure that user can use product correctly through this manual to avoid danger or property damage during operation. Before using this product, please read the manual carefully and save it for future reference.

Without written permission, no unit or individual may extract, copy, translate, or modify all or part of this manual in any way. Unless otherwise agreed, the company does not provide any express or implied statement or guarantee for this manual.

## About this manual

Use this manual as a guide. The photos, graphics, diagrams, and illustrations provided in the manual are for reference only. They may differ from specific products. Please refer to actual product. The company may update this manual due to product version upgrades or other needs. If you need the latest version of the manual, please log on to the company's official website to check.

It is recommended that you use this manual under professional person guidance

## Disclaimer

1.To the maximum extent permitted by law, the products described in this manual (including hardware, software, firmware, etc.) are provided "as is" and may have defective or errors. The company does not provide any form or Implied warranties, including but not limited to warranties of merchantability, quality satisfaction, fitness for a particular purpose, and non-infringement of third-party rights; nor does it impose any special, incidental, incidental, or indirect damages resulting from the use of this manual or the use of our products Compensation, including but not limited to loss of business profits, loss of data or documents.

2.If you connect the product to Internet, the product may be subject to network attacks, hackers, and virus infections. you have to bear risk by yourself. But we will provide you with technical support in time.



3. When using this product, please strictly follow the applicable laws. If the product is used for infringing the rights of third parties or other improper uses, the company will not bear any responsibility.

If the contents of this manual conflict with applicable laws, the legal provisions shall prevail.

## Sign convention

The description of the symbols that appear in the document is shown below.

### Sign Description

1.  说明 Descriptive text, which supplements and explains the text.
2.  警告 Warning texts indicate potential risks. If not avoided, they may cause injury, equipment damage, or business interruption.
3.  危险 Dangerous text indicates that there is a high potential risk. If it is not avoided, it may cause Serious danger of personal injury or death.

### Tips:

To protect your privacy and improve product security, we strongly recommend that you set a more complex password according to the following rules: 8-16 characters, consisting of two or more types of numbers, uppercase and lowercase letters, and special characters Made.

Please understand that you are responsible for properly configuring all passwords and other related product security settings.

## Chapter 1: Product Overview

7-inch temperature measurement panel	7-inch temperature measurement panel with vertical bracket
	7-inch temperature measurement panel with wall bracket
8-inch temperature measurement panel	8-inch temperature measurement panel with vertical bracket
	8-inch temperature measurement panel with wall bracket

### 1.1 Product Introduction

The 8-inch temperature measurement panel is a perfect combination of traditional applications based on face recognition and infrared temperature detection. Suit for Hotel, access gate, office building, school, shopping mall, communities, public services

### 1.2 Product Features

- (1) Using high-precision infrared temperature detector non-contact automatic body temperature detection, accurate and efficient;
- (2) Temperature measurement range: 30-45 [ C ]  
Accuracy can reach  $\pm 0.3$
- (3) Real-time output of identify results and voice prompts;
- (4) Auto identify people without masks and give real-time warning;
- (5) Auto register and record information, avoid manual operation, improve efficiency and reduce missing information;
- (6) Dual sensor with living detect, face recognition distance 0.3-3M,
- (7) Face recognition within 500ms; Face library 22400 person. Total can storage 100,000 recognize record;
- (8) Rich interface protocols, supporting SDK and HTTP protocols under multiple platforms such as Windows / Linux
- (9) Supporting machine vision optical dynamics  $\geq 80$ dB, suitable for backlight environment monitor;

- (10) Supports fog, 3D noise reduction, strong light suppression, electronic image stabilization, and has multiple white balance modes, suitable for various scene requirements;
- (11) Linux operate system ,more stable.

### 1.3 Packing list

Temperature measurement panel	1 unit
Installation and user manual	1 pcs
Warranty card	
Spare parts package	Post: 1 set of waterproof network head, 6 pcs tie Wall mount: 1 1 pcs accessory kit, 1 pcs gimbal bracket, 1 pcs wall mount bracket, 1 set of waterproof network head

## Chapter 2: Appearance



## Pigtail interface description:

No.	Name	Description
J1	WG OUT	1:D0 2:D1 3:GND
J2	WG IN	NC
J3	ALARM OUT	RELAY SWITCH
J4	USB	USB Interface
J5	RJ45	100M
J6	DC12V	POWER IN 12V/3A



No.	Name	Description
J1	Multifunctional interface	WG OUT: Orange D0、White D1、Green GND
		WG IN: Brown and white D0、Yellow D1、Gray GND
		ALARM OUT: Brown ALARM+、Purple ALARM
		RS485: Orange and White 485+、 Blue and White 485
		USB: Red 5V、 Blue D-、 Green and white D+、 Black GND
J2	RJ45	100M
J3	Power supply interface	POWER IN12V/3A

## Precautions

1. Device working temperature : 10 ℃ -40 ℃. Do not Install under the

- vent and ensure that there is no heating source within 3 meters;
2. People entering the room from a cold outdoor environment will affect measurement accuracy. The forehead temperature test needs to be performed indoors without covering the forehead for three minutes and the temperature is stable;
3. The temperature read by the temperature measuring device is the temperature in the forehead area. When there is water, sweat, oil or thick makeup on the forehead, or the elderly have wrinkles, the read temperature will be lower than the actual temperature. Make sure there is no hair or clothing covering this area.

## Gate installation

According to the requirements of the installation site, in the space position on the gate or in the front side, the opening diameter of the 7-inch access control machine is 30mm, and the opening diameter of the 8-inch access control machine is 35mm. The diagram is as follows:

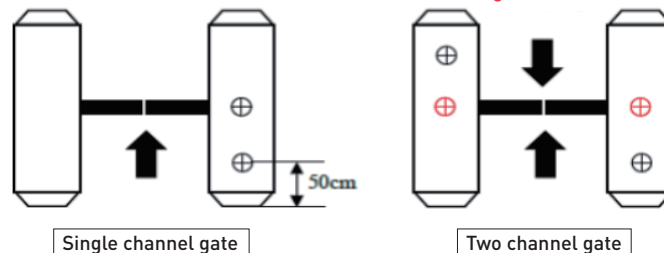

### 1.2 Adjust angle of temperature detector

After the temperature measurement access control is fully activated, the human face is directly facing the device. Observe the face image on the device screen. Make sure that the bare skin on the forehead is placed in the "temperature measurement area" (optimal temperature detector distance 0.5m). After that, paste the "Please stand here" detection position mark at the corresponding distance.

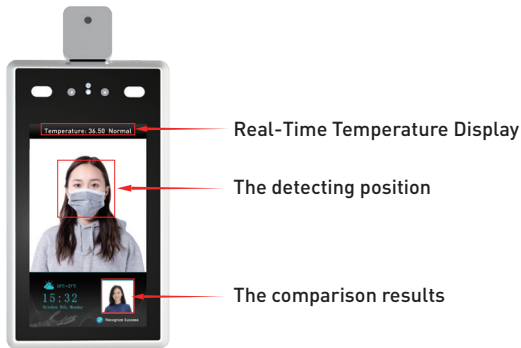

**Note:** Due to the height of the gate installation, it may cause the test personnel to actively cooperate during the test to ensure that the bare skin on the forehead is placed in the "temperature measurement area".

## 2. Temporary test position, (Tripod mounting)



### 2.1 Temperature measurement panel with vertical bracket:

Attach the cable tie from the "Accessory Pack" to the tripod for the temperature measurement access control on the column,

### Temperature measurement panel with wall bracket:

Mount the gimbal bracket in the "Accessory Pack" to the tripod for the wall-mounted temperature measurement access control. Connect the power supply and network cable

### 2.2 Adjust to best angle and detection position of the detector, as image below:

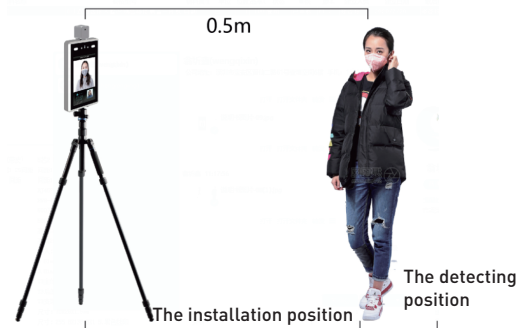

**2.3** After temperature detect are confirmed , make detect position mark on the ground for accurate detection.

**Note:** There is no need to move or adjust the relevant position or height after installation is completed. Due to the height difference of the inspected person, the inspected person may need to cooperate actively to ensure the accuracy of the inspection data.

### 3.Wall mounting

Note: The installation height of 1.5 meters here is the recommended installation height, and users can adjust it according to their height.

### Installation with 86 boxes

**Step 1:** Make holes in the wall according to the mounting bracket and install 86 boxes.

**Step 2:** Use a special tamper-proof wrench to loosen the tamper-resistant fixing screws at the bottom of the device, remove the mounting plate, and

The hanging plate is fixed on the 86 box as shown below.

**Step 3:** Hang the device from top to bottom on the mounting plate.

**Step 4:** Use a special tamper wrench at the bottom of the device to lock the tamper screws .

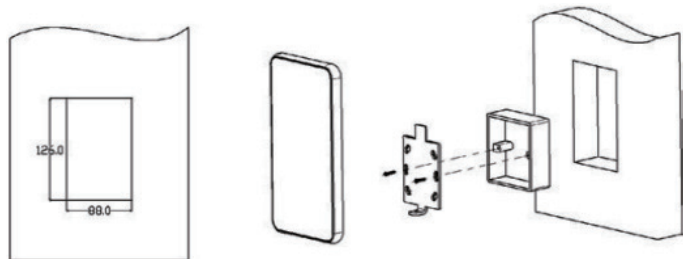

### Installation without 86 boxes:

**Step 1:** Fix the mounting base on the mounting wall as shown in the figure below.

**Step 2:** Use a special tamper-proof wrench to loosen the tamper-resistant fixing screws at the bottom of the device, remove the mounting plate, and lock it to the mounting base plate according to the hole position.

**Step 3:** Hang the device from top to bottom on the mounting plate.

**Step 4:** Use a special tamper wrench at the bottom of the device to lock the tamper screws .

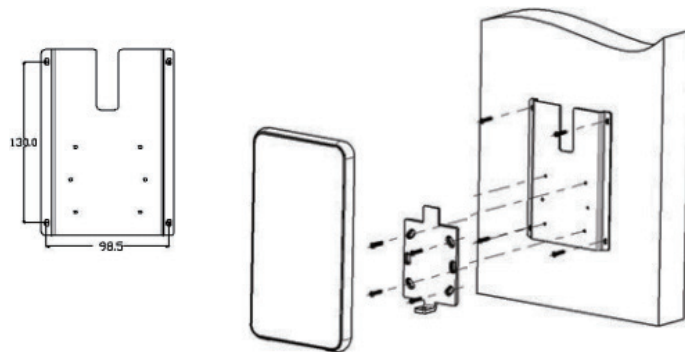

## Chapter 4: Instructions

### 4.1 IE config and environment setup

In the environment where the IP Camera and all aspects of the network work normally, open the IE browser, input default IP:192.168.1.88 , to enter the login interface, and set the login password. [Note: Login password security level Must be medium or high otherwise the setting is unsuccessful]. For the first time using the login interface, please click [Download Address] to download and install the controls. If there is a warning on the page, click [Allow Access].

For the first time, please set up the password activation device.

Set Password:

Confirm password:

Low Medium High

**Notice:**  
Password setting could to 8-15 non-null characters and must consist of three types: number (0-9), uppercase letter (A-Z), lowercase letter (a-z) and two special characters ("." and "\_")  
Please setting password according to security high-or-weaknesses guideness  
[Download The ActiveX plugin](#)

Login

Download the control manually, or enter the password and follow the system prompts to install the control.



Pop up file download dialog interface. Select [Run] or [Save] to download. After the download is complete, double-click the download file WebCMS.exe and click the "Run" button. Install according to the prompts, and click "Finish" at the end to complete the control installation, as shown in the figure below.

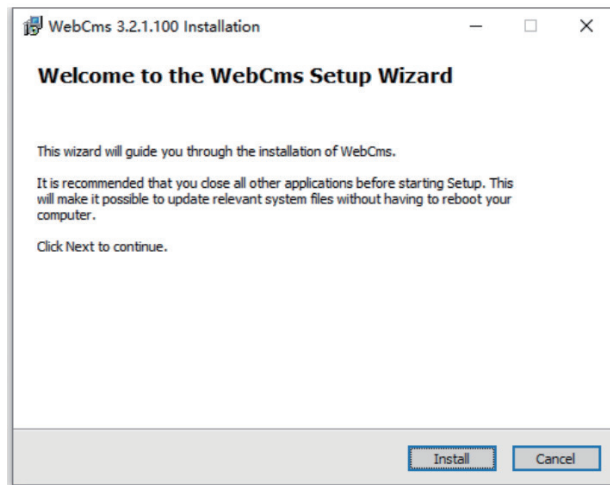

**Note:** The control is installed abnormally and the solution: 1. When downloading and installing the control according to the prompts, when prompted with the information in the following figure, please manually modify the IE security level in IE Tools-Internet Options-Security Level-Custom Security Level. Modify the parameters as shown below:

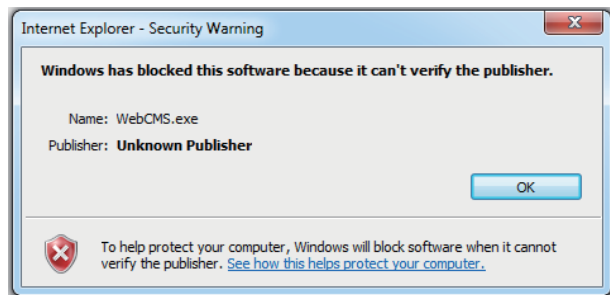

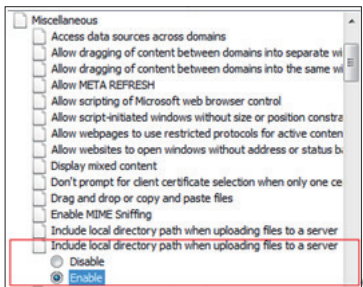
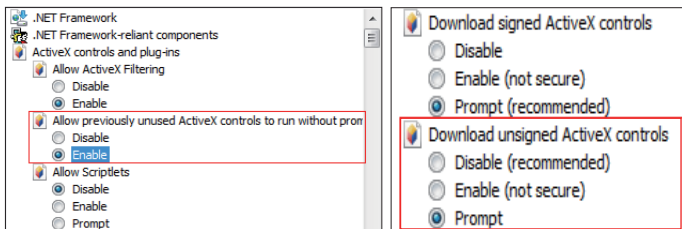
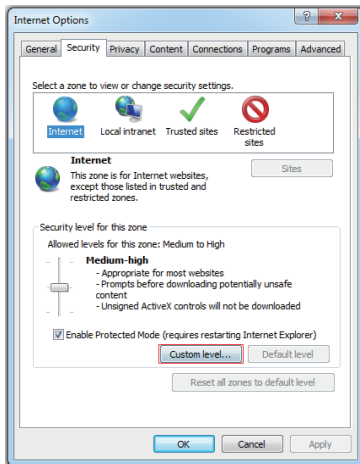

**4.1.2** Follow prompts to install the controls normally. When the installation process is half way, you will be prompted with the information shown in the following figure. Please close the browser and click [Retry] to install the controls correctly:

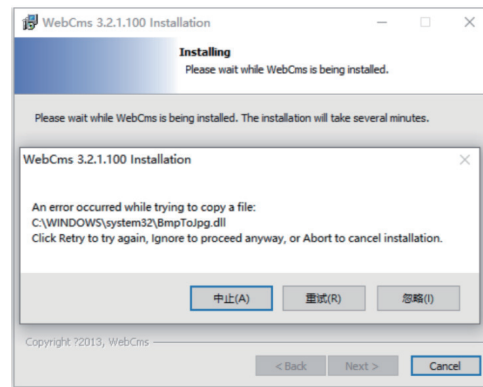

## 4.2 Intelligent analysis-

### 4.2.1 Face recognition alarm settings

#### 1. Recognize mode

Customers can choose different recognize modes according to different application scenarios, which are divided into three types: face recognition, temperature detect, and face + temperature detect;

#### 2. Mask detection

Mask detect can be selected, close or open. When detect no wear mask, it will output warning;

#### 3. Temperature threshold

The temperature threshold can be set between 35-45 °C, and the default value is 37.3 °C. Customers can be adjust



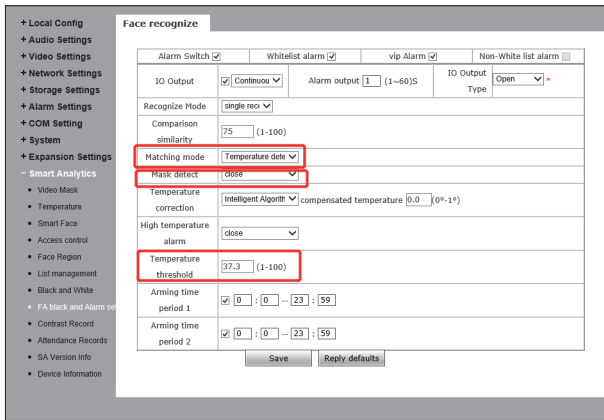

## 4.2.2 Face recognise parameter setting

### 1.Switch

This item used to enable face recognition algorithm. Only when the switch open, face recognise and capture can be performed, and other parameters can take effect;

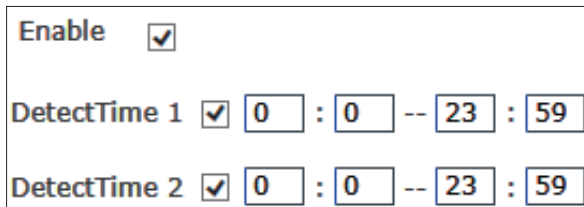

### 2. Arming time

This item is the control time. The user can define two time periods. To make it take effect, check the box next to the "arming time period". Both time periods are enabled by default. The default time is 00:00-23: 59.

### 3.Sensitivity

The setting range is 0 ~ 10. The default sensitivity is 5. The higher sensitivity, the poorer quality of captured picture; the lower the sensitivity, the higher image quality . for normal, adjusting to 3 ~ 5 is better.



### 4.Capture mode

The access control machine defaults to "single mode"

Single mode: used with "interval frames", the default capture: 8 times, and interval frames : 5 frames

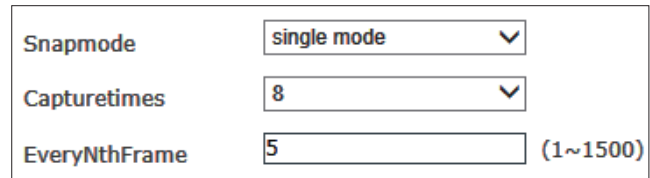

**Description:** Trial scene access control and gate. When multiple people pass the gate, only the front one (the face pixel in the picture is the largest) will be captured. According to the set interval frames, one face photo will be captured and uploaded to the FTP server. There is only one face frame in the picture.

### 5.Maximum and minimum pixels for face recognition

- ① The maximum pixel setting range for face recognition: 300 ~ 500. Default: 500
- ② Face recognition minimum pixel setting range: 30 ~ 300. Default: 130
- ③ When the pixels of the face in the picture are less than 130 (the smallest pixels for face recognition), can't capture; when the pixels of the face in the picture are more than 500 (the largest pixels for face recognition), also can't capture.

Face recognition maximum pixel	<input type="text" value="500"/>	(300~500)
FaceMinPixel	<input type="text" value="160"/>	(30~300)

#### 6.Face scene

This parameter setting is used to adopt different face exposure strategies for different application scenarios. There are two modes: normal scene and lobby

Face scene	<input type="text" value="Conventional scene"/>
	<input type="text" value="Lobby scene"/>

scene. The default is [Lobby Scene]. Ordinary scene: used in normal environment; lobby scene: suitable for backlight environment.

#### 7.Face tracking

This parameter is used to overlay the face tracking . [Open] by default.

FaceTrack	<input type="text" value="Close"/>
	<input type="text" value="Filter Tracking"/>

#### 8.Living detect

This parameter is used for living detect. The default state [Open].

Live detection	<input type="text" value="Close"/>
----------------	------------------------------------

#### 4.2.3 Face recognize - Parameter setting

Area setting, only capture face in restricted area. Only can set one area [Off] by default.

#### 4.2.4 Face recognize and area mask

When a masking area is set, the faces in the area are masked. Set up to 4 areas.default is [Close]

#### 4.2.5 Access control

Weigan output

Weigan output is off by default. Support WG26, WG34 output.

#### 2.Self-light control

① Self-light control is [Self-light time control] by default, and the light duration is [10] seconds.

② Note: The self-light lamp is controlled by motion detect. When there is a motion detect alarm, the self-light lamp is on. After 10 seconds without alarm, the self-light lamp off and the screen off.

#### 4.2.6Face recognition, white list & VIP list

Face database divided into black and white lists. When a person added to library list and passed by the camera, it will have recognize record on log .

Picture Style	<input type="text" value="Snap"/>
---------------	-----------------------------------

#### Capture: Import picture by real-time capture

Step 1: Select default capture mode

Step 2: Input a name for the picture

Step 3: Input a ID number for the image

Step 4: Click to add white or VIP list

#### Import: Import way, as shown in the figure below.

Step 1: Select picture type

Step 2: Click Browse and select the image according to the storage path.

Step 3: Click Upload to upload the face image to be imported.

- Step 4: Enter a name for the picture name
- Step 5: Enter picture number or ID number
- Step 6: Click to add white or VIP list

Picture name and number rules: Picture name + picture ID number cannot be repeated, single item can be repeated, ID and mobile phone number can be optional.

#### 4.2.7 Face recognize.alarm setting

You can set related alarms for white and VIP list.

#### 4.2.8 Face recognize.alarm setting

You can set related alarms for white and VIP list.

#### 4.2.9 Face recognize. records

You can query the latest 100,000 comparison records; you can query the comparison results of a certain list or for designed person.

#### Query conditions:

1. Time period query: You can enter any time period to query the comparison records in the specified time period.
2. List query: select any list to query the comparison records of the specified list
- 3, name and number query: you can enter the name and number of any person who already exists for specific query

#### 4.3 Fast setting for application

##### 4.3.1 Face recognize + temperature control

1. In "Intelligent Analysis-Face Recognize Alarm Settings", select "Recognize Mode" for "Face"
  - + Temperature detection "Choose whether to open" mask detection "
- (mask detection is default close)

2. Set the temperature threshold, default is 37.3 °C

Temperature threshold	<input type="text" value="37.3"/> (1-100)
-----------------------	---

3. Input face list library

list management

Picture Style:

List type:

Upload:

Picture: 

Name:  ID:

ID card:  phone number:

4. Setting is completed and can be used . Face recognize success + temperature normal, allowed to pass; face recognize success + temperature fail, will be refuse to pass.

### 5. Record query

Face recognize comparison record query, can be query based on time, list library, or precise query by name and number;

Face recognize

Condition: 2020 - 3 - 31 00:00 - 2020 - 4 - 1 23:59 | All Library | Name:  number:

Routing Mac	name	Serial number	list	body temperature	time	Detail situation
	-	-	Nomodelist	36.26	2020-04-01 09:20:11	Mask-No, Temperature normal
	-	-	Nomodelist	36.64	2020-04-01 09:28:11	Mask-No, Temperature normal
	-	-	Nomodelist	36.59	2020-04-01 09:24:06	Mask-No, Temperature normal
	-	-	Nomodelist	36.62	2020-04-01 09:19:24	Mask-No, Temperature normal
	-	-	Nomodelist	36.51	2020-04-01 09:19:06	Mask-No, Temperature normal
	-	-	Nomodelist	36.54	2020-04-01 09:18:13	Mask-No, Temperature normal

Last page  54 Current page

### 4.3.2 Temperature control + face record

1. In "Intelligent Analysis-Face Recognize Alarm Settings", select "Recognize Mode" for "Face+ Temperature detection "Choose whether to open" mask detection "

Face recognize

Alarm Switch  Whitelist alarm  vip Alarm  Non-White list alarm

IO Output  Continuous  Alarm output  (1-60)S IO Output Type

Recognize Mode:

Comparison similarity:  (1-100)

Matching mode:

Mask detect:

Temperature correction:  compensated temperature  (0\*-1\*)

High temperature alarm:

Temperature threshold:  (1-100)

Arming time period 1:  0 : 0 - 23 : 59

Arming time period 2:  0 : 0 - 23 : 59

2. Set the temperature threshold, default is 37.3 °C

Temperature threshold	<input type="text" value="37.3"/> (1-100)
-----------------------	---

3. Setting is completed and can be used . Face recognize success + temperature normal, allowed to pass; face recognize success + temperature fail, will be refuse to pass.

4. Record query same as item 5 in 4.3.1

## The specific drawing size:

7-inch temperature measurement panel with vertical bracket

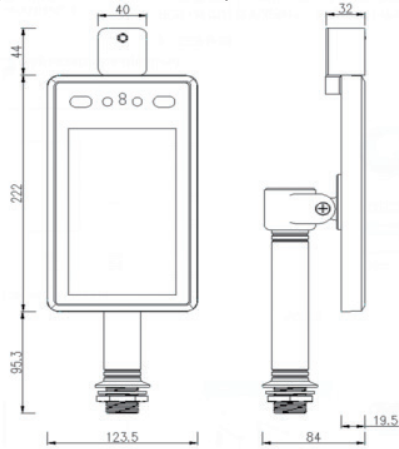

7-inch temperature measurement panel with wall bracket

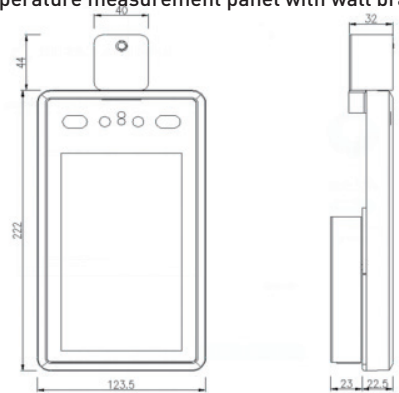

8-inch temperature measurement panel with vertical bracket

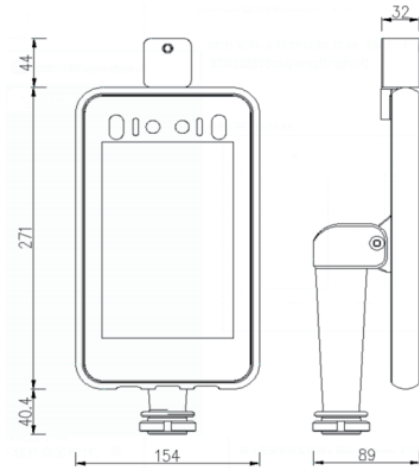

8-inch temperature measurement panel with wall bracket

